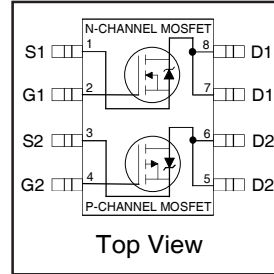


# IRF7338PbF

HEXFET® Power MOSFET

- Ultra Low On-Resistance
- Dual N and P Channel MOSFET
- Surface Mount
- Available in Tape & Reel
- Lead-Free

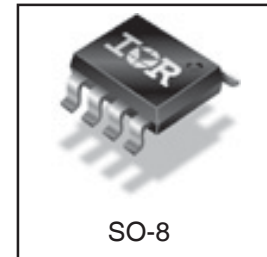


	N-Ch	P-Ch
$V_{DS}$	12V	-12V
$R_{DS(on)}$	0.034Ω	0.150Ω

## Description

These N and P channel MOSFETs from International Rectifier utilize advanced processing techniques to achieve the extremely low on-resistance per silicon area. This benefit provides the designer with an extremely efficient device for use in battery and load management applications.

This Dual SO-8 has been modified through a customized leadframe for enhanced thermal characteristics and multiple-die capability making it ideal in a variety of power applications. With these improvements, multiple devices can be used in an application with dramatically reduced board space. The package is designed for vapor phase, infrared, or wave soldering techniques.



## Absolute Maximum Ratings

	Parameter	Max.		Units
		N-Channel	P-Channel	
$V_{DS}$	Drain-to-Source Voltage	12	-12	A
$I_D @ T_A = 25^\circ\text{C}$	Continuous Drain Current, $V_{GS} @ 4.5\text{V}$	6.3	-3.0	
$I_D @ T_A = 70^\circ\text{C}$	Continuous Drain Current, $V_{GS} @ 4.5\text{V}$	5.2	-2.5	
$I_{DM}$	Pulsed Drain Current ①	26	-13	
$P_D @ T_A = 25^\circ\text{C}$	Power Dissipation ③	2.0		W
$P_D @ T_A = 70^\circ\text{C}$	Power Dissipation ③	1.3		
	Linear Derating Factor	16		mW/°C
$V_{GS}$	Gate-to-Source Voltage	±12 ④	± 8.0	V
$T_J, T_{STG}$	Junction and Storage Temperature Range	-55 to + 150		°C

## Thermal Resistance

Symbol	Parameter	Typ.	Max.	Units
$R_{\theta JL}$	Junction-to-Drain Lead	—	20	°C/W
$R_{\theta JA}$	Junction-to-Ambient ③	—	62.5	

## Electrical Characteristics @ T<sub>J</sub> = 25°C (unless otherwise specified)

Parameter	Description	N-Ch	P-Ch	Min.	Typ.	Max.	Units	Conditions
				Min.	Typ.	Max.		
V <sub>(BR)DSS</sub>	Drain-to-Source Breakdown Voltage	N-Ch	12	—	—	V	V <sub>GS</sub> = 0V, I <sub>D</sub> = 250μA	
		P-Ch	-12	—	—			V <sub>GS</sub> = 0V, I <sub>D</sub> = -250μA
ΔV <sub>(BR)DSS</sub> /ΔT <sub>J</sub>	Breakdown Voltage Temp. Coefficient	N-Ch	—	0.01	—	V/°C	Reference to 25°C, I <sub>D</sub> = 1mA Reference to 25°C, I <sub>D</sub> = -1mA	
		P-Ch	—	-0.01	—			
R <sub>DS(ON)</sub>	Static Drain-to-Source On-Resistance	N-Ch	—	—	0.034	Ω	V <sub>GS</sub> = 4.5V, I <sub>D</sub> = 6.0A ②	
			—	—	0.060		V <sub>GS</sub> = 3.0V, I <sub>D</sub> = 2.0A ②	
		P-Ch	—	—	0.150		V <sub>GS</sub> = -4.5V, I <sub>D</sub> = -2.9A ②	
			—	—	0.200		V <sub>GS</sub> = -2.7V, I <sub>D</sub> = -1.5A ②	
V <sub>GS(th)</sub>	Gate Threshold Voltage	N-Ch	0.6	—	1.5	V	V <sub>DS</sub> = V <sub>GS</sub> , I <sub>D</sub> = 250μA	
		P-Ch	-0.40	—	-1.0		V <sub>DS</sub> = V <sub>GS</sub> , I <sub>D</sub> = -250μA	
g <sub>fs</sub>	Forward Transconductance	N-Ch	9.2	—	—	S	V <sub>DS</sub> = 6.0V, I <sub>D</sub> = 6.0A ②	
		P-Ch	3.5	—	—		V <sub>DS</sub> = -6.0V, I <sub>D</sub> = -1.5A ②	
I <sub>DSS</sub>	Drain-to-Source Leakage Current	N-Ch	—	—	20	μA	V <sub>DS</sub> = 9.6V, V <sub>GS</sub> = 0V	
		P-Ch	—	—	-1.0		V <sub>DS</sub> = -9.6V, V <sub>GS</sub> = 0V	
		N-Ch	—	—	50		V <sub>DS</sub> = 9.6V, V <sub>GS</sub> = 0V, T <sub>J</sub> = 55°C	
		P-Ch	—	—	-25		V <sub>DS</sub> = -9.6V, V <sub>GS</sub> = 0V, T <sub>J</sub> = 55°C	
I <sub>GSS</sub>	Gate-to-Source Forward Leakage	N-Ch	—	—	±100	nA	V <sub>GS</sub> = ±12V	
		P-Ch	—	—	±100		V <sub>GS</sub> = ±8.0V	
Q <sub>g</sub>	Total Gate Charge	N-Ch	—	—	8.6	nC	N-Channel I <sub>D</sub> = 6.0A, V <sub>DS</sub> = 6.0V, V <sub>GS</sub> = 4.5V	
		P-Ch	—	—	6.6			
Q <sub>gs</sub>	Gate-to-Source Charge	N-Ch	—	—	1.9	nC	P-Channel I <sub>D</sub> = -2.9A, V <sub>DS</sub> = -9.6V, V <sub>GS</sub> = -4.5V	
		P-Ch	—	—	1.3			
Q <sub>gd</sub>	Gate-to-Drain ("Miller") Charge	N-Ch	—	—	3.9	nC	P-Channel I <sub>D</sub> = -2.9A, V <sub>DS</sub> = -9.6V, V <sub>GS</sub> = -4.5V	
		P-Ch	—	—	1.6			
t <sub>d(on)</sub>	Turn-On Delay Time	N-Ch	—	6.0	—	ns	N-Channel V <sub>DD</sub> = 6.0V, I <sub>D</sub> = 1.0A, R <sub>G</sub> = 6.0Ω, V <sub>GS</sub> = 4.5V	
		P-Ch	—	9.6	—			
t <sub>r</sub>	Rise Time	N-Ch	—	7.6	—	ns	P-Channel V <sub>DD</sub> = -6.0V, I <sub>D</sub> = -2.9A, R <sub>G</sub> = 6.0Ω, V <sub>GS</sub> = -4.5V	
		P-Ch	—	13	—			
t <sub>d(off)</sub>	Turn-Off Delay Time	N-Ch	—	26	—	ns	P-Channel V <sub>DD</sub> = -6.0V, I <sub>D</sub> = -2.9A, R <sub>G</sub> = 6.0Ω, V <sub>GS</sub> = -4.5V	
		P-Ch	—	27	—			
t <sub>f</sub>	Fall Time	N-Ch	—	34	—	ns	P-Channel V <sub>DD</sub> = -6.0V, I <sub>D</sub> = -2.9A, R <sub>G</sub> = 6.0Ω, V <sub>GS</sub> = -4.5V	
		P-Ch	—	25	—			
C <sub>iss</sub>	Input Capacitance	N-Ch	—	640	—	pF	N-Channel V <sub>GS</sub> = 0V, V <sub>DS</sub> = 9.0V, f = 1.0MHz	
		P-Ch	—	490	—			
C <sub>oss</sub>	Output Capacitance	N-Ch	—	340	—	pF	P-Channel V <sub>GS</sub> = 0V, V <sub>DS</sub> = -9.0V, f = 1.0KHz	
		P-Ch	—	80	—			
C <sub>rss</sub>	Reverse Transfer Capacitance	N-Ch	—	110	—	pF	P-Channel V <sub>GS</sub> = 0V, V <sub>DS</sub> = -9.0V, f = 1.0KHz	
		P-Ch	—	58	—			

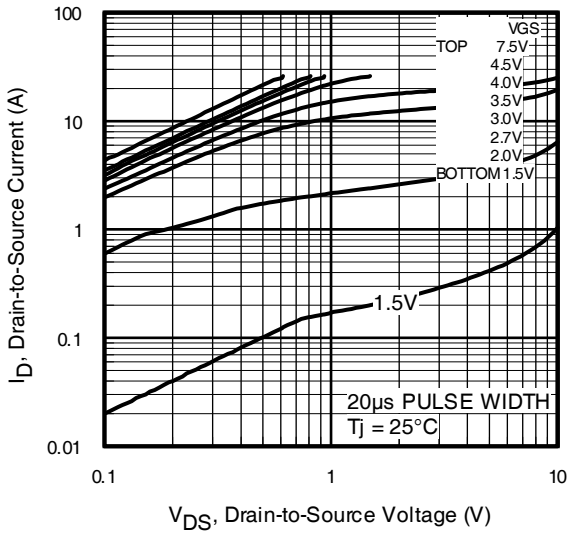
## Source-Drain Ratings and Characteristics

Parameter	Description	N-Ch	P-Ch	Min.	Typ.	Max.	Units	Conditions
				Min.	Typ.	Max.		
I <sub>S</sub>	Continuous Source Current (Body Diode)	N-Ch	—	—	6.3	A		
		P-Ch	—	—	-3.0			
I <sub>SM</sub>	Pulsed Source Current (Body Diode) ①	N-Ch	—	—	26	A		
		P-Ch	—	—	-13			
V <sub>SD</sub>	Diode Forward Voltage	N-Ch	—	—	1.3	V	T <sub>J</sub> = 25°C, I <sub>S</sub> = 1.7A, V <sub>GS</sub> = 0V ②	
		P-Ch	—	—	-1.2		T <sub>J</sub> = 25°C, I <sub>S</sub> = -2.9A, V <sub>GS</sub> = 0V ②	
t <sub>rr</sub>	Reverse Recovery Time	N-Ch	—	51	76	ns	N-Channel T <sub>J</sub> = 25°C, I <sub>F</sub> = 1.7A, di/dt = 100A/μs	
		P-Ch	—	37	56			
Q <sub>rr</sub>	Reverse Recovery Charge	N-Ch	—	43	64	nC	P-Channel T <sub>J</sub> = 25°C, I <sub>F</sub> = -2.9A, di/dt = -100A/μs ②	
		P-Ch	—	20	30			

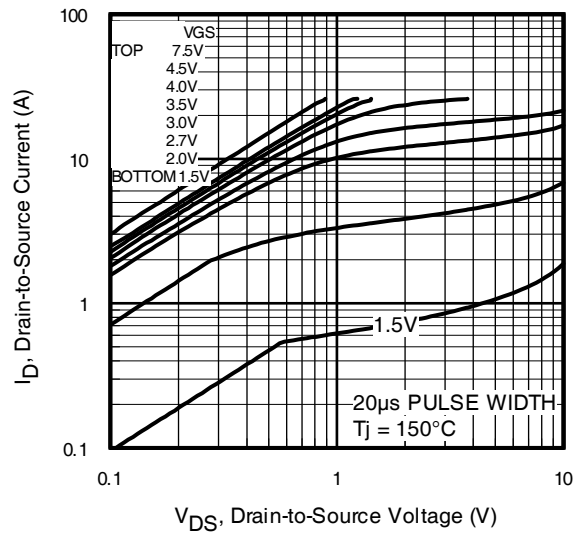
### Notes:

- ① Repetitive rating; pulse width limited by max. junction temperature.  
② Pulse width ≤ 400μs; duty cycle ≤ 2%.

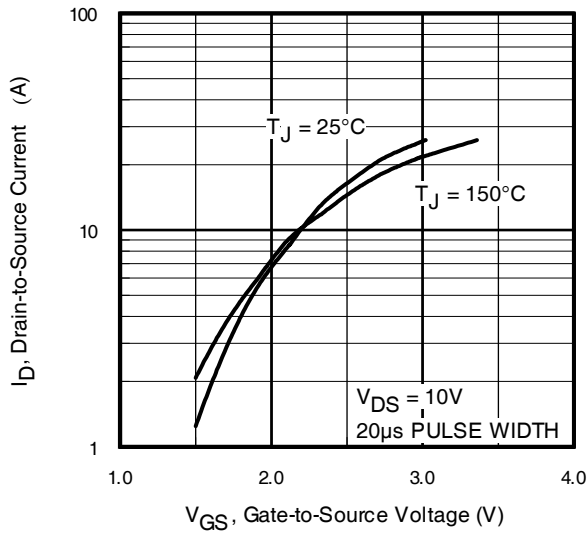
- ③ Surface mounted on 1 in square Cu board.  
④ The N-channel MOSFET can withstand 15V V<sub>GS</sub> max for up to 24 hours over the life of the device.



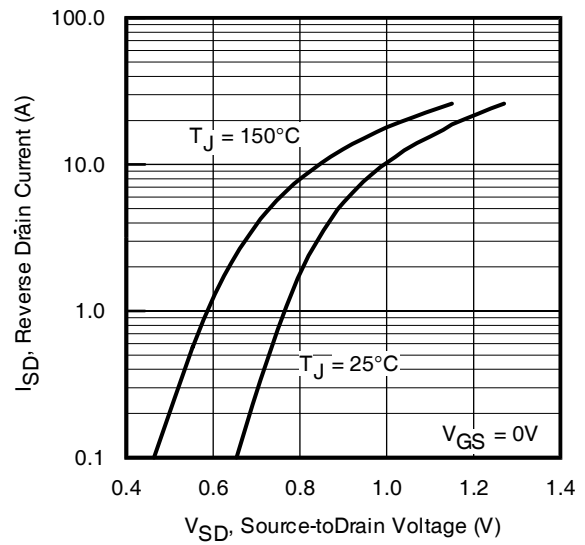
**Fig 1.** Typical Output Characteristics



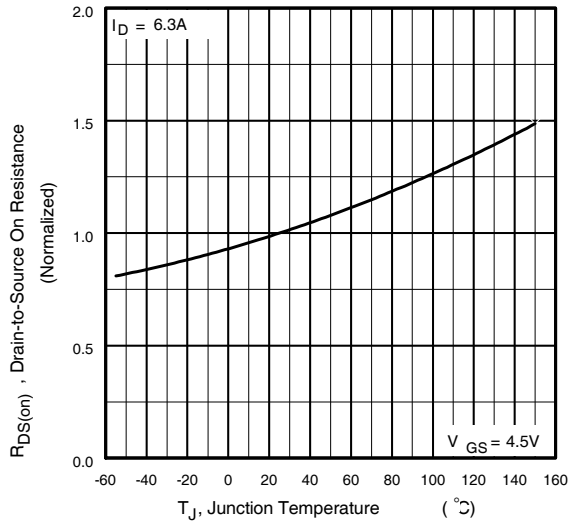
**Fig 2.** Typical Output Characteristics



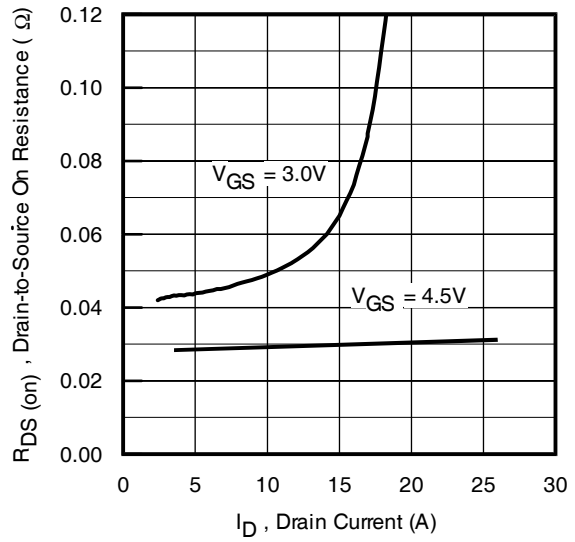
**Fig 3.** Typical Transfer Characteristics



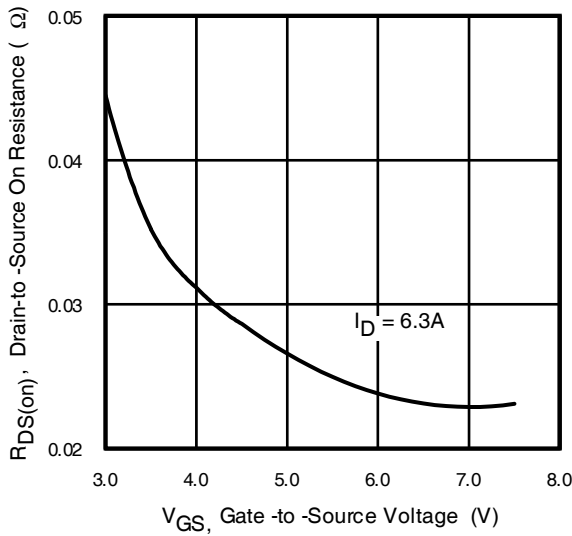
**Fig 4.** Typical Source-Drain Diode Forward Voltage



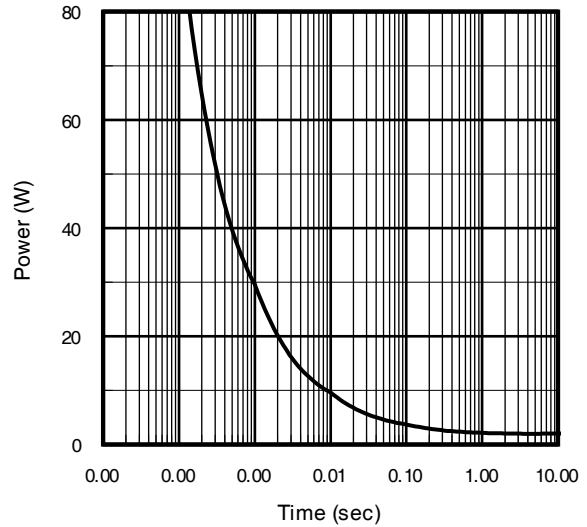
**Fig 5.** Normalized On-Resistance Vs. Temperature



**Fig 6.** Typical On-Resistance Vs. Drain Current



**Fig 7.** Typical On-Resistance Vs. Gate Voltage



**Fig 8.** Typical Power Vs. Time

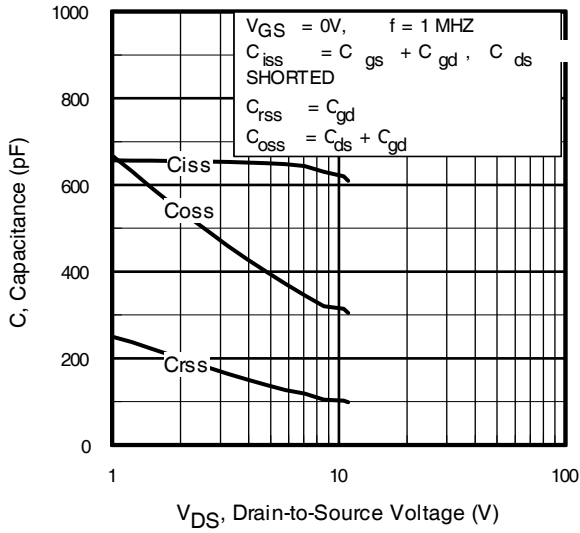


Fig 9. Typical Capacitance Vs. Drain-to-Source Voltage

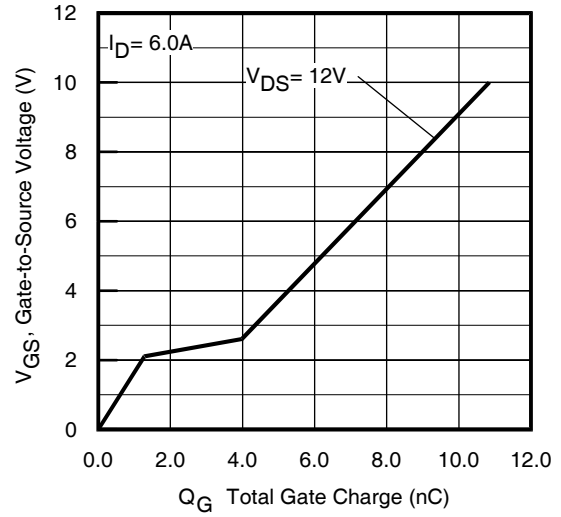


Fig 10. Typical Gate Charge Vs. Gate-to-Source Voltage

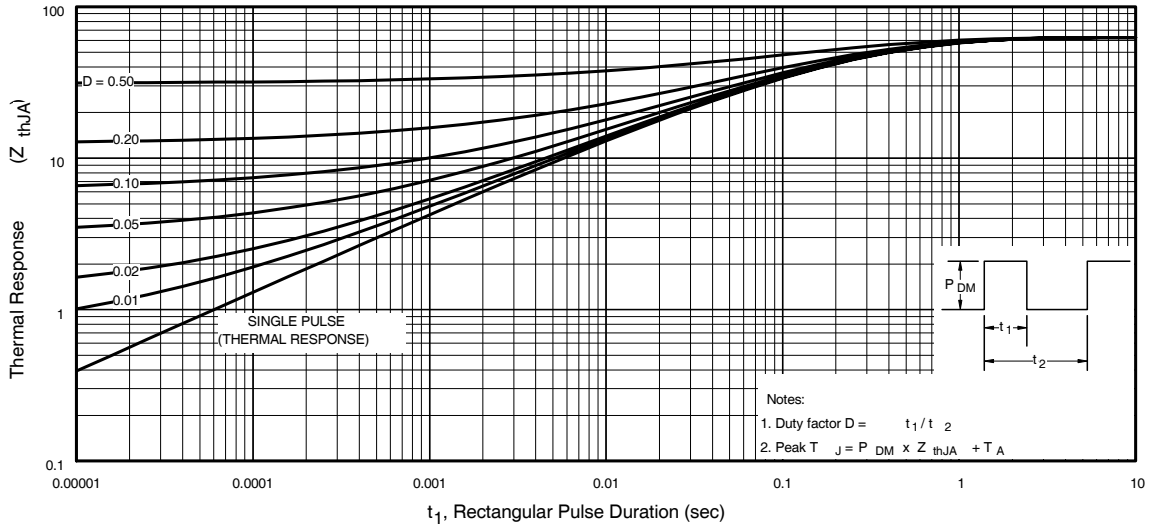
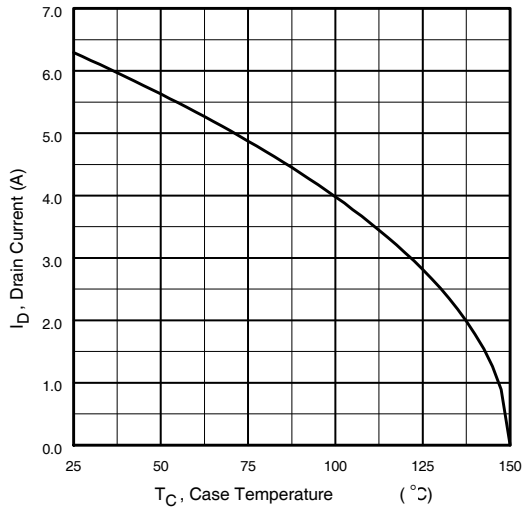


Fig 11. Maximum Effective Transient Thermal Impedance, Junction-to-Ambient

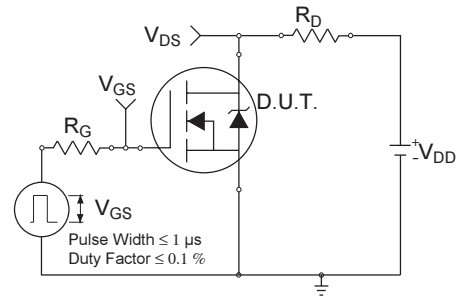
# IRF7338PbF

N-Channel

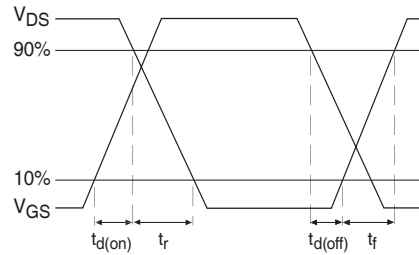
International  
**IR** Rectifier



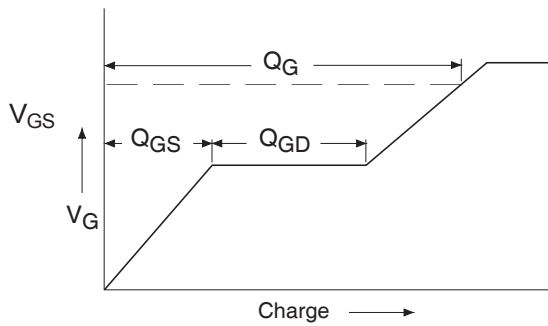
**Fig 12.** Maximum Drain Current Vs. Case Temperature



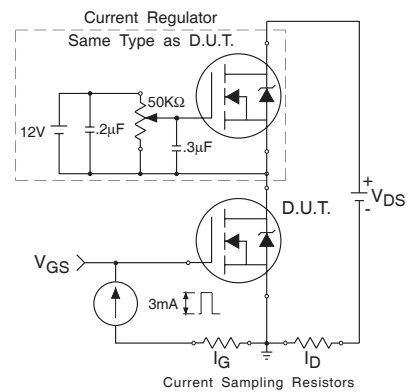
**Fig 13a.** Switching Time Test Circuit



**Fig 13b.** Switching Time Waveforms



**Fig 14a.** Basic Gate Charge Waveform



**Fig 14b.** Gate Charge Test Circuit

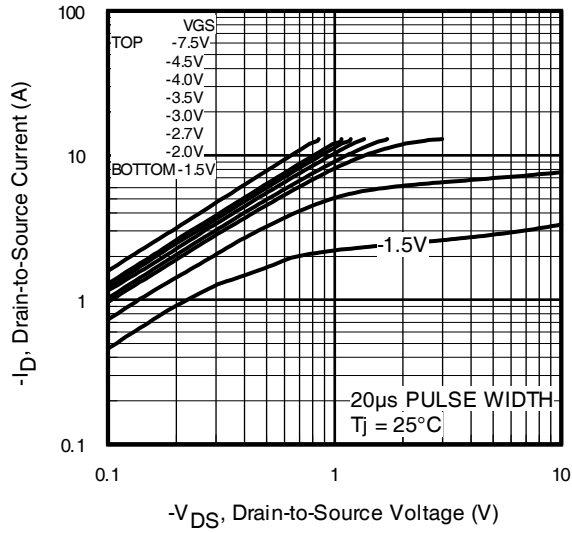


Fig 15. Typical Output Characteristics

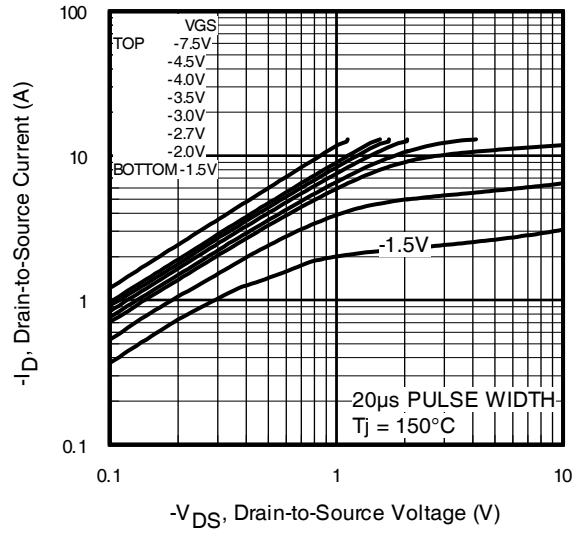


Fig 16. Typical Output Characteristics

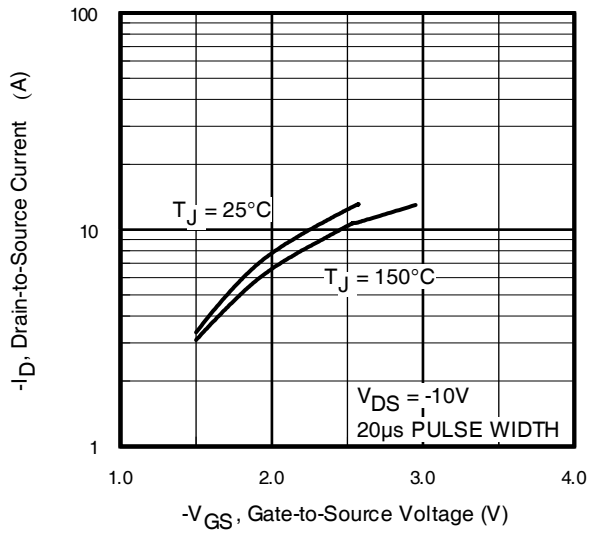


Fig 17. Typical Transfer Characteristics

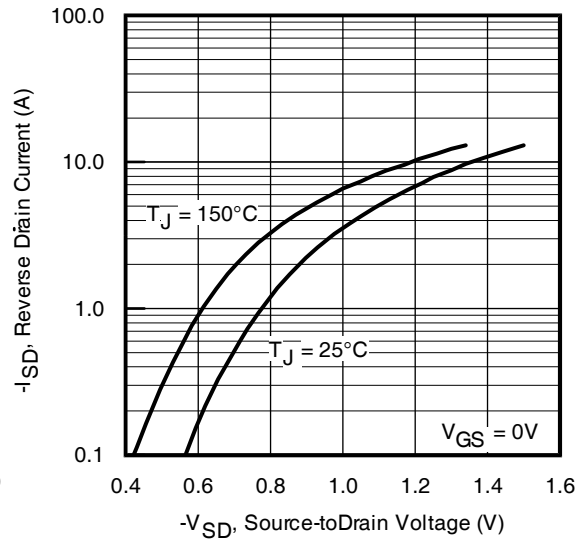
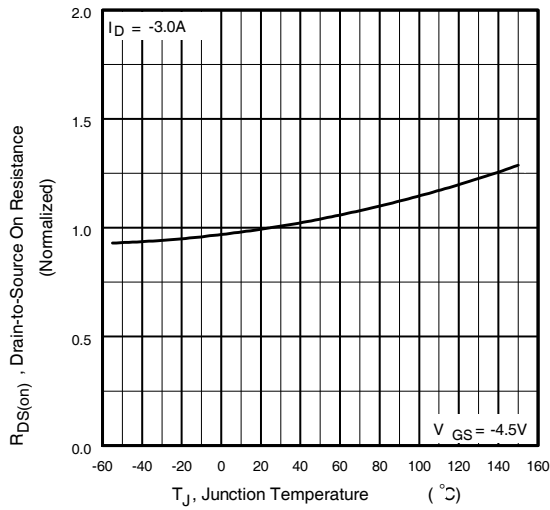
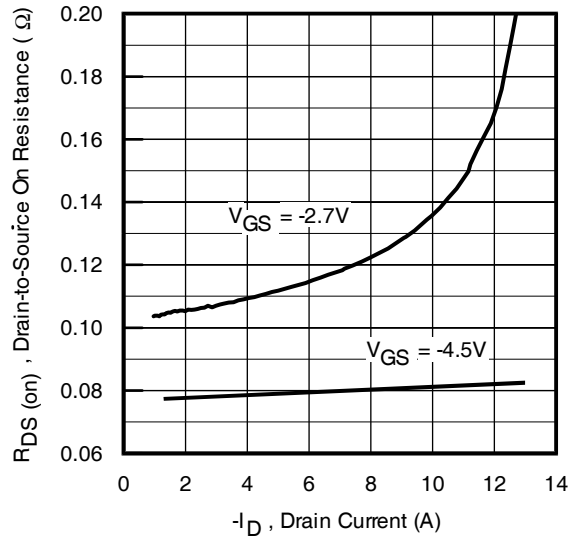


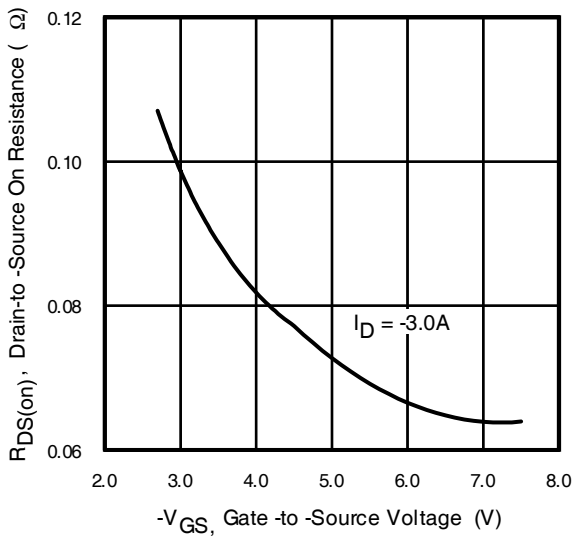
Fig 18. Typical Source-Drain Diode Forward Voltage



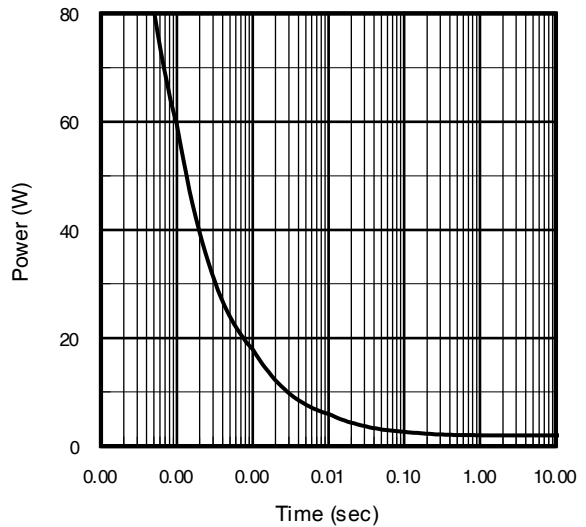
**Fig 19.** Normalized On-Resistance Vs. Temperature



**Fig 20.** Typical On-Resistance Vs. Drain Current

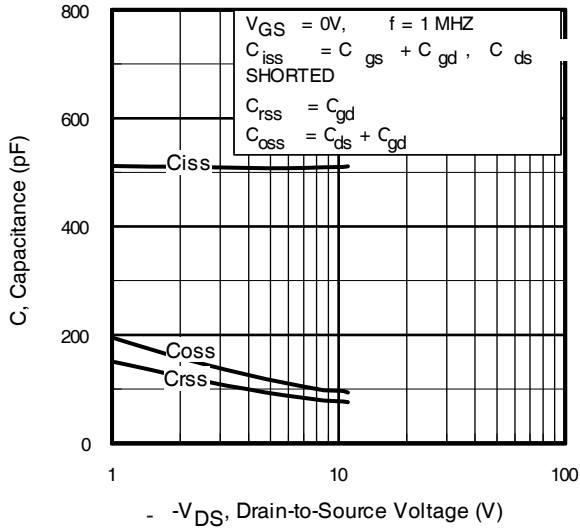


**Fig 21.** Typical On-Resistance Vs. Gate Voltage

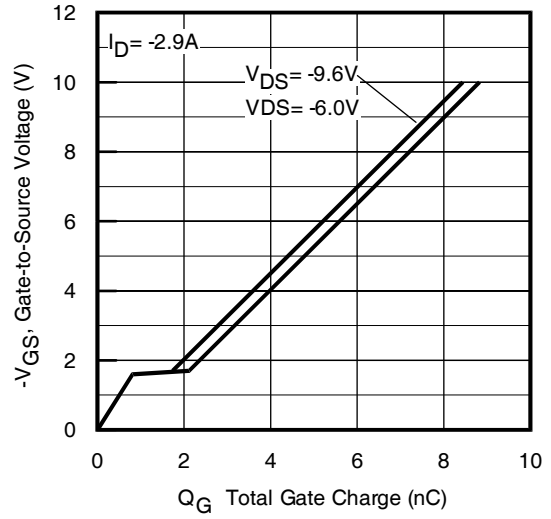


**Fig 22.** Maximum Avalanche Energy Vs. Drain Current

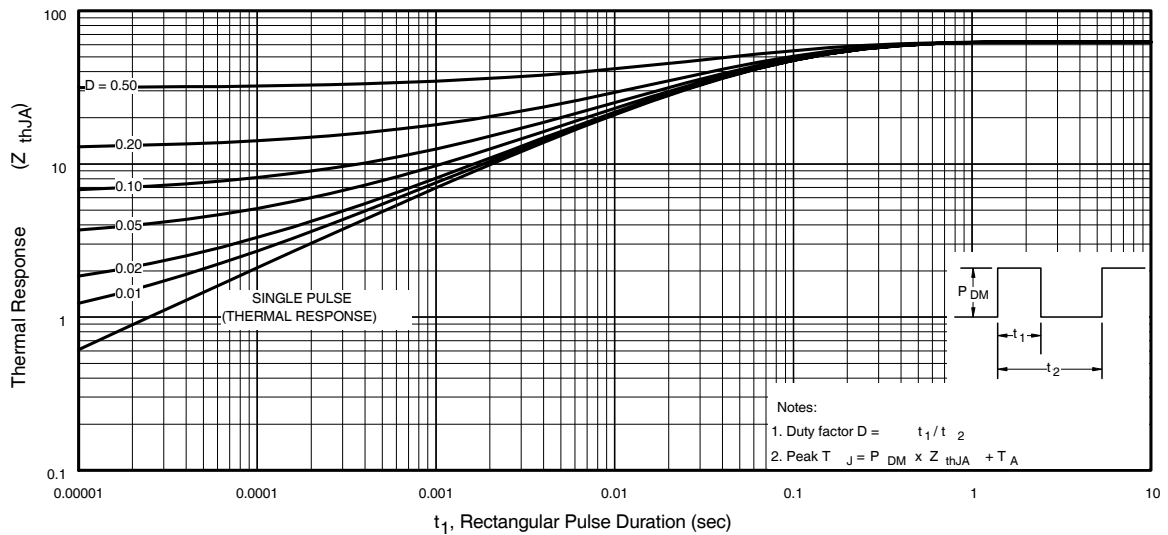




**Fig 23.** Typical Capacitance Vs. Drain-to-Source Voltage



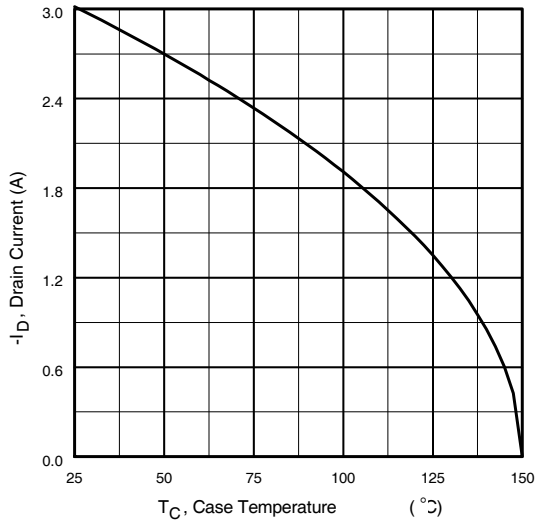
**Fig 24.** Typical Gate Charge Vs. Gate-to-Source Voltage



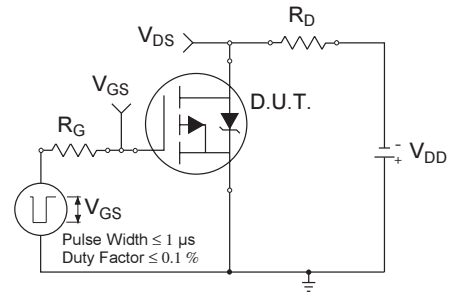
**Fig 25.** Maximum Effective Transient Thermal Impedance, Junction-to-Ambient

# IRF7338PbF

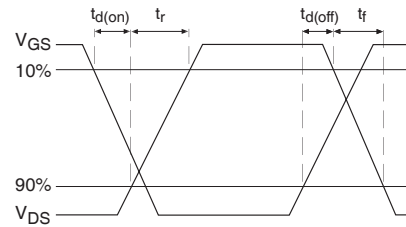
International  
**IR** Rectifier



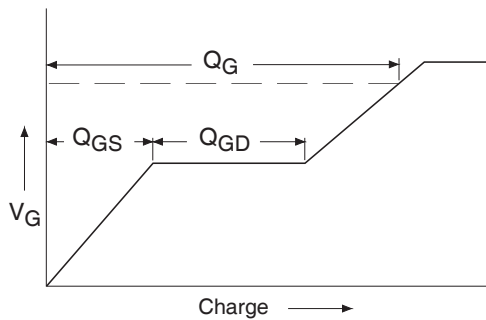
**Fig 26.** Maximum Drain Current Vs. Case Temperature



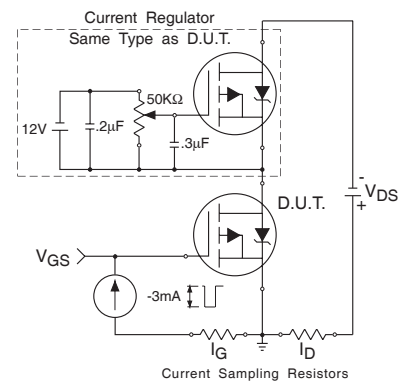
**Fig 27a.** Switching Time Test Circuit



**Fig 27b.** Switching Time Waveforms



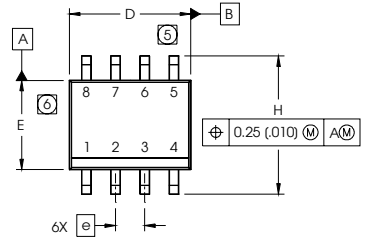
**Fig 28a.** Basic Gate Charge Waveform



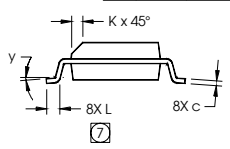
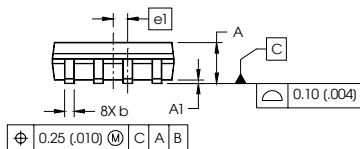
**Fig 28b.** Gate Charge Test Circuit

## SO-8 Package Outline

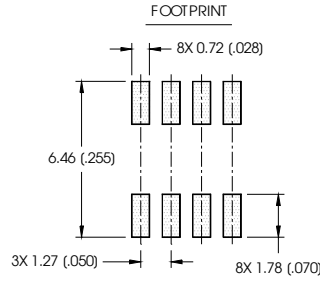
Dimensions are shown in millimeters (inches)



DIM	INCHES		MILLIMETERS	
	MIN	MAX	MIN	MAX
A	.0532	.0688	1.35	1.75
A1	.0040	.0098	0.10	0.25
b	.013	.020	0.33	0.51
c	.0075	.0098	0.19	0.25
D	.189	.1968	4.80	5.00
E	.1497	.1574	3.80	4.00
e	.050 BASIC		1.27 BASIC	
e1	.025 BASIC		0.635 BASIC	
H	.2284	.2440	5.80	6.20
K	.0099	.0196	0.25	0.50
L	.016	.050	0.40	1.27
y	0°	8°	0°	8°

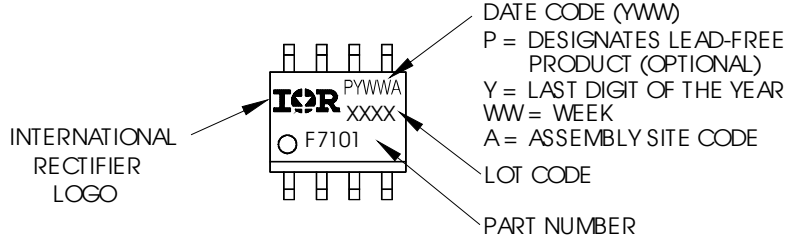


- NOTES:
1. DIMENSIONING & TOLERANCING PER ASME Y14.5M-1994.
  2. CONTROLLING DIMENSION: MILLIMETER
  3. DIMENSIONS ARE SHOWN IN MILLIMETERS (INCHES).
  4. OUTLINE CONFORMS TO JEDEC OUTLINE MS-012AA
  - ⑤ DIMENSION DOES NOT INCLUDE MOLD PROTRUSIONS. MOLD PROTRUSIONS NOT TO EXCEED 0.15 (.006).
  - ⑥ DIMENSION DOES NOT INCLUDE MOLD PROTRUSIONS. MOLD PROTRUSIONS NOT TO EXCEED 0.25 (.010).
  - ⑦ DIMENSION IS THE LENGTH OF LEAD FOR SOLDERING TO A SUBSTRATE.



## SO-8 Part Marking Information (Lead-Free)

EXAMPLE: THIS IS AN IRF7101 (MOSFET)

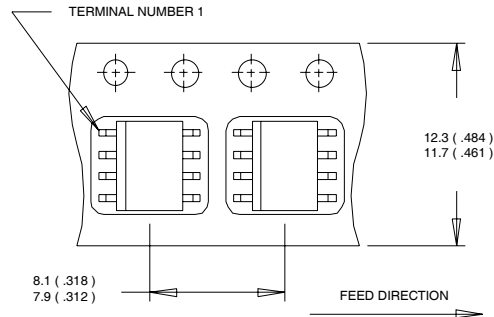


# IRF7338PbF

International  
**IR** Rectifier

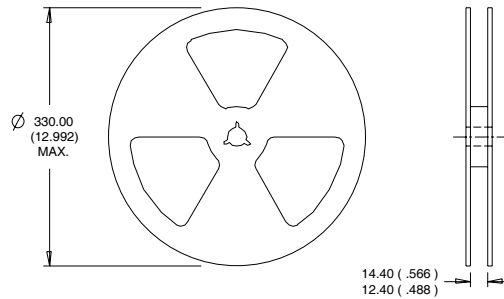
## SO-8 Tape and Reel

Dimensions are shown in millimeters (inches)



NOTES:

1. CONTROLLING DIMENSION : MILLIMETER.
2. ALL DIMENSIONS ARE SHOWN IN MILLIMETERS(INCHES).
3. OUTLINE CONFORMS TO EIA-481 & EIA-541.



NOTES :

1. CONTROLLING DIMENSION : MILLIMETER.
2. OUTLINE CONFORMS TO EIA-481 & EIA-541.

Data and specifications subject to change without notice.  
This product has been designed and qualified for the Consumer market.  
Qualification Standards can be found on IR's Web site.

International  
**IR** Rectifier

**IR WORLD HEADQUARTERS:** 233 Kansas St., El Segundo, California 90245, USA Tel: (310) 252-7105  
TAC Fax: (310) 252-7903

Visit us at [www.irf.com](http://www.irf.com) for sales contact information.09/04

[www.irf.com](http://www.irf.com)